

# 4K UHD All-in-One Video Camera

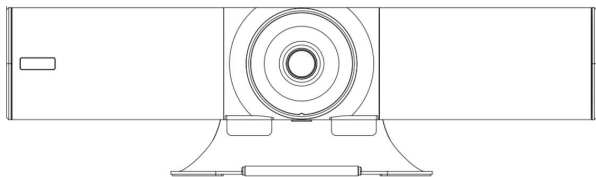

(V2.0)

J.BC.0205.0150

# 4K UHD All-in One Video Camera

## PACKING LIST

Check all bellow items when open the package:

Camera	1
Power Adapter	1
Power Cable	1
Type-C Cable	1
Remote Controller	1
User Manual	1
QC certification	1

## QUICK START

1. Check all cable connections before power on.

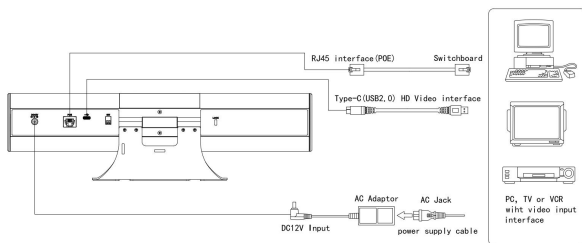

2. Dial Switch Setting (on the back of the camera):

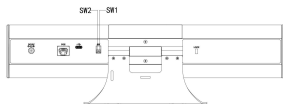

Back dial code			
Mode	SW-1	SW-2	Instruction
1	OFF	*	Updating mode
2	ON	*	Working mode
SW-2 is reserved, no function defined			

## 4K UHD All-in One Video Camera

---

### PRODUCT ADVANTAGES:

- Adopt advanced DSP, Sony 1/2.8 inch 8.42 megapixel sensor and high quality 12 megapixel lens, to output Ultra high definition, crystal clear image.
- USB2.0 YUY2/NV12/MJPG/H.264/H.265 video format, works with Windows, MAC OS, Android, Linux OS.
- Type-C port output.
- 120degree field of viewing.
- Lens distortion rate less than 4% (120°FOV).
- Support WDR, 3DNR, Anti-flicker feature.
- Standard UVC 1.1 protocol, compatible with your favorite video conferencing software and platform.
- The low noise CMOS effectively enables the ultra-high signal-to-noise ratio of the camera video, and keeps clear and sharp image even under the condition of ultra-low illumination.
- Support Auto frame: Auto frame participants at meeting start or enter, leave, or change positions; Auto frame can be closed via remote controller.
- **Uses Microphone Array Algorithms**  
By sampling and processing the spatial characteristics of sound field, the background sound can be removed to the maximum extent, leaving only the needed sound waves, even in the noisy environment, it can make the voice sound clear without noise.
- **High Definition Audio**  
16K pickup and 24K playback, to make voice crystal clear, sounding like face-to-face meeting.  
360° Omni-directional pickup, the pickup range is up to 5 meters and voice quality is most ideal in 3 meters.
- **Outstanding Full Duplex Communication**  
Freely and fluent two-ways communication in 5 meters.

## 4K UHD All-in One Video Camera

---

- **Advanced Speech Algorithms**
  - 360° Omni-directional and long distance pick
  - Full duplex communication
  - 384ms acoustic echo cancellation
  - Background noise suppression
  - Auto-level loud and soft voices
  - Peak-limiting algorithm eliminates even momentary speaker clipping to prevent distortion

### PRODUCT SPEC

Model		4K UHD All-in-One Video Camera
<b>Sensor</b>		1/2.8 inch high quality, 8.42 megapixel SONY CMOS sensor
<b>Video Format</b>	Type-C (USB2.0)	YUY2, NV12: 1280*720@15; 1024*576@20; 640*480@30
		MJPEG: 3840*2160@30; 2560*1440@30; 1920*1080@30; 1280*720@30; 1024*576@30; 640*480@30
		H.264, H.265: 3840*2160@20; 2560*1440@30; 1920*1080@30; 1280*720@30; 1024*576@30; 640*480@30
<b>Digital Zoom</b>		4X
<b>Field of Viewing</b>		120°
<b>Sensor Resolution</b>		8.42 megapixel
<b>Control Port</b>		USB2.0(UVC/UAC)

## 4K UHD All-in One Video Camera

<b>Video Port</b>	Type-C(USB2.0)
<b>S/N Ratio</b>	>50dB
<b>Focal Length</b>	f=2.20mm
<b>Minimum Lux.</b>	0.1 lux
<b>White Balance</b>	Auto/Manual
<b>Iris</b>	F 2.2
<b>Anti-Flicker</b>	50HZ/60HZ/OFF
<b>WDR</b>	Supported
<b>Edge Enhancement</b>	Supported
<b>Digital Noise Reduction</b>	2D&3D
<b>Image Flip</b>	Supported
<b>Electronic Pan/Tilt</b>	Supported
<b>Auto frame</b>	Supported
<b>Backlight Compensation</b>	Supported
<b>Voice Pick Distance</b>	3~5meters
<b>USB Audio</b>	Supported
<b>Microphone</b>	Omnidirectional microphone(100~16KHz)
<b>Sensitivity</b>	-26±2dB RL=2.2KΩ Vs=2.0V
<b>Input Voltage</b>	DC+12V
<b>Speaker</b>	4Ω/8W 100-24KHz 2inch Anti-magnetic speaker
<b>RJ45</b>	POE(IEEE802.3af)
<b>Dimension(L × W × H)</b>	395mm×113mm×112mm
<b>Net Weight</b>	1kg (2.2LB)

# 4K UHD All-in One Video Camera

## CAMERA INTERFACE:

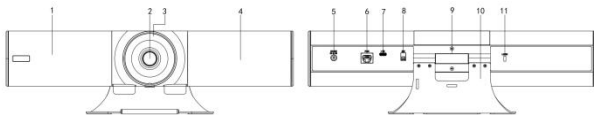

1. Speaker
2. Camera lens
3. Status indicator light
4. Multi array microphone
5. DC12V power interface
6. RJ45 interface (POE)
7. Type-C (USB2.0) interface
8. Dial switch
9. Adjustable spindle
10. Rotatable bracket
11. Safety cord interface

## CAMERA DIMENSION(mm):

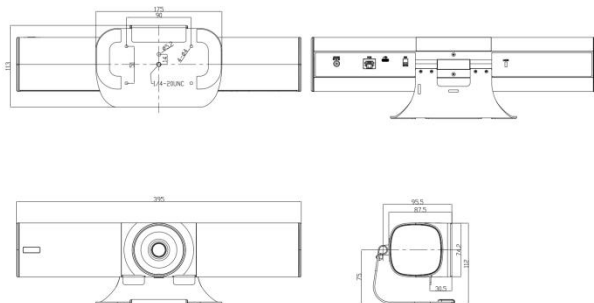

# 4K UHD All-in One Video Camera

## INSTALLATION MODES:



Installation Method 1:  
Put the device on flat surface



Installation Method 2:  
Put the device on top of the screen

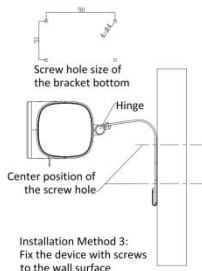

# 4K UHD All-in One Video Camera

## INSTRUCTIONS FOR WIRELESS REMOTE CONTROL:



### LED function indication:

Press any button to show red color: it means that the present selection is to control camera 1;

Press any button to show green color: it means that the present selection is to control camera 2;

Press any button to show blue color: it means that the present selection is to control camera 3.

### CAM1/CAM 2/CAM3:

Press the key shortly to select the camera to be controlled, press the key for 3s to set the camera address.



### Zoom adjustment key: +/-

Adjust the electronic zoom, only available when Auto frame is closed.

### Power key:

Standby / start camera.

### BLC:

Set backlight compensation ON or OFF.

### Navigation key: up, down, left and right

In normal working mode, it is used to adjust the position of electronic pan tilt or select menu items after entering the menu.



### Confirm / Home key:

In the normal working mode, shortly press to return the electronic pan tilt to home position. Or after entering the menu, it is used to confirm the menu options.

### Menu key:

In normal working mode, press to enter the menu, and then press to exit the menu.



### Volume control key:

Control the volume or mute.



### Video Mute/Micro Mute:

Video Mute and microphone mute.





# 4K UHD All-in One Video Camera

## A/M:

Auto frame/Manual frame.



## PUSH Frame:

In Auto frame off mode, you can manually trigger the Auto frame once.



## Preset key:

Long press for 3 seconds to save the current position to the corresponding preset position, shortly press to call the preset position, only available when Auto frame is closed.



## Mirror /Flip:



## Reset:

Press and hold for 3S to reset the camera parameters to the factory settings.



## Digital key reuse:

As shown in the figure on the right, in non-menu mode, this part of the key is used for the function identified on the key; in menu mode, this part of the key is used as a numeric key.

## OSD menu

1. In normal working mode, press the menu button  on the IR remote, to enter the OSD menu; press the menu button again to exit and save modified parameters.



2. Use the navigate button to select the main menu. As above picture, once been selected, the main menu will change to grey color background, and the right side will show all parameters under this sub menu.

3. When enter into the main OSD menu, press the up/down navigate button to select the sub menu, use left/right navigate button to set the parameter.

4. If you need to return back the last level menu, select the "return" and then press the left or right navigate button to get back to previous menu.



5. Press OSD button  again to exit the menu.

## 4K UHD All-in One Video Camera

### 6. OSD Menu Layout:

SYSTEM	LANGUA	ENGLISH/CHINESE	
	PROTOCO	Optional item:VISCA	Default: VISCA
	ADDRESS	VISCA:1~7	Default: 1
	BAUDRAT	2400,4800,9600,115200 optional	Default: 9600
	RETURN	Back to the main menu	

EXPOSURE	EXP.MODE	AUTO/MANU	Default: AUTO
	SHUTTER	Shutter speed:1/30~1/10000, only valid under MANU mode	Default: 1/100
	GAIN	Gain setting:0~15, only valid under MANU mode	Default: 0
	FLICK	OFF/50HZ/60HZ	Default: 50HZ
	BACKLIGH	ON/OFF	Default: OFF
	GAMMA	0~15	Default: 8
RETURN	Back to the main menu		

IMAGE	WB MODE	AUTO/MANU	Default: AUTO
	B GAIN	Blue gain level:0~256, only valid under	Default: 100
	R GAIN	Red gain level:0~256, only valid under	Default: 100
	DEFOG	Set the image permeability:OFF/1~15	Default: OFF
	RETURN	Back to the main menu	

QUALITY	2D NR	Set 2D noise reduction level:ON/OFF	Default: OFF
	3D NR	Set 3D noise reduction level:OFF/AUTO/1~4	Default: AUTO
	SHARPNES	Sharpness setting:0~15	Default: 8
	CONTRAST	Contrast setting:0~15	Default: 8
	SATURATI	Saturation setting:0~15	Default: 8
	BRIGHT	Bright setting:0~15	Default: 8
	RETURN	Back to the main menu	

CTRL	MIRROR	Turn the screen left and right ON/OFF	Default: OFF
	FLIP	Picture up and down ON/OFF	Default: OFF
	AUTO FRAME	AUTO/MANU	Default: AUTO
	RETURN	Back to the main menu	

RESET	CAM RESET	Reset camera parameter to default	
	RETURN	Back to the main menu	

INFO	CTRL VER	Camera movement control program version	
	CTRL DATE	Release date of camera movement control program	
	RETURN	Back to the main menu	